

VOLVO PENTA INDUSTRIAL DIESEL

TAD1345VE

394 kW (536 hp) at 2100 rpm acc. to ISO 3046

The TAD1345VE is a powerful, reliable and economical Versatile Diesel Engine built on the dependable Volvo in-line six concept.

Durability & low noise

Designed for easy, fast and economical installation. Field tested to ensure highest standard of durability and long life. Well-balanced to produce smooth and vibration-free operation with low noise levels and high torque.

To maintain a controlled working temperature in cylinders and combustion chambers, the engine is equipped with piston cooling. The engine is also fitted with replaceable cylinder liners and valve seats/guides to ensure maximum durability and service life of the engine.

Low exhaust & noise emission

The state of the art, high-tech injection and highly efficient charge air system with low internal losses contributes to excellent combustion and low fuel consumption.

The TAD1345 VE complies with EU Stage 2 / EPA Tier 2 emissions. An electronically controlled viscous fan drive is available giving substantially lower noise and fuel consumption.

Easy service & maintenance

Easily accessible service and maintenance points contribute to the ease of service of the engine.

Technical description

Engine and block

- Cast iron cylinder block with optimum distribution of forces without the block being unnecessarily heavy.
- Wet, replaceable cylinder liners
- Piston cooling for low piston temperature and reduced ring temperature
- Tapered connecting rods for increased piston lifetime
- Crankshaft induction hardened bearing surfaces and fillets with seven bearings for moderate load on main and high-end bearings
- Case hardened and Nitrocarburized transmission gears for heavy duty operation
- Keystone top compression rings for long service life
- Viscous type crankshaft vibration dampers
- Replaceable valve guides and valve seats
- Over head camshaft and four valves per cylinder



Features

- High torque
- Highly efficient cooling system with Air to Air Intercooler
- High power density
- Fully electronic with EMS 2
- Complies with EU Stage 2 / EPA Tier 2 emissions
- Wide range of optional equipment including visco fan.

Lubrication system

- Full flow oil cooler
- Full flow disposable spin-on oil filter, for extra high filtration
- The lubricating oil level can be measured during operation
- Gear type lubricating oil pump, gear driven by the transmission
- Oil level sensor at startup

Fuel system

- Electronic high pressure unit injectors
- Fuel prefilter with water separator and water-in-fuel indicator / alarm
- Gear driven low-pressure fuel pump
- Fine fuel filter with manual feed pump and fuel pressure switch

Cooling system

- Efficient cooling with accurate coolant control through a water distribution duct in the cylinder block. Reliable sleeve thermostat with minimum pressure drop
- Belt driven coolant pump with high degree of efficiency
- Electronically controlled viscous fan drive provides lower noise and fuel consumption (optional).

Turbo charger

- Efficient and reliable turbo charger
- Electronically controlled Waste-gate
- Extra oil filter for the turbo charger

Electrical system

- Engine Management System 2 (EMS 2), an electronically controlled processing system which optimizes engine performance. It also includes advanced facilities for diagnostics and fault tracing.
- Possibility to perform a start battery test according to the NCPA requirements via CAN bus signals.
- The instruments and controls connect to the engine via the CAN SAE J1939 interface, either through the Control Interface Unit (CIU) or the Digital Control Unit (DCU). The CIU converts the digital CAN bus signal to an analog signal, making it possible to connect a variety of instruments. The DCU is a control panel with display, engine control, monitoring, alarm, parameter setting and diagnostic functions. The DCU also presents error codes in clear text.
- Sensors for oil pressure, oil temp, boost pressure, boost temp, coolant temp, fuel temp, water in fuel, fuel pressure and two speed sensors.

**VOLVO
PENTA**

TAD1345VE

Technical Data

General

Engine designation	TAD1345VE
No. of cylinders and configuration	in-line 6
Method of operation	4-stroke
Bore, mm (in.)	131 (5.16)
Stroke, mm (in.)	158 (6.22)
Displacement, l (in ³)	12.78 (780)
Compression ratio	18.1:1
Wet weight, engine only, kg (lb)	1237 (2921)

Performance

IFN power without fan, at 2100rpm kW (hp)	394 (536)
IFN power with fan Ø 890 mm, at 2100rpm kW (hp)	368 (500)
ICFN power without fan, at 1800rpm kW (hp)	394 (536)
ICFN power with fan Ø 890 mm, at 1800rpm kW (hp)	377 (513)
Torque at 1260 rpm, Nm (lb ft)	2325 (1715)

Lubrication system

Oil system capacity incl filters, liter (US gal)	36 (9.51)
--	-----------

For details see Technical Data

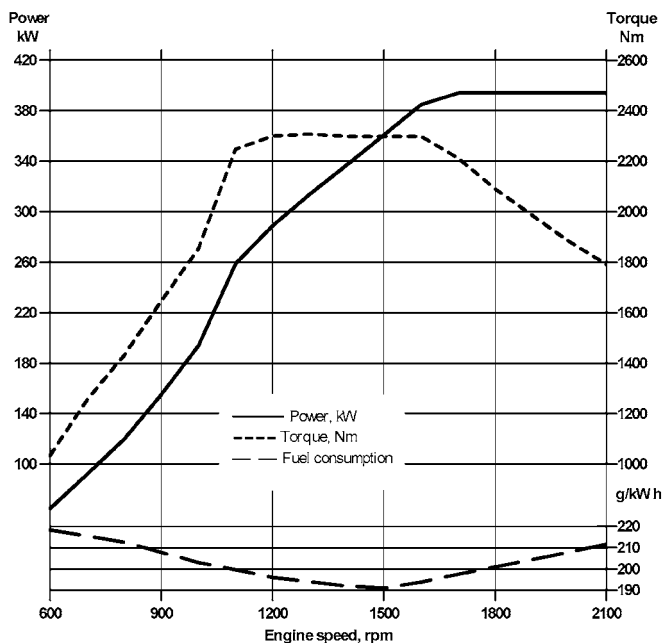

Dimensions TAD1345VE

Not for installation

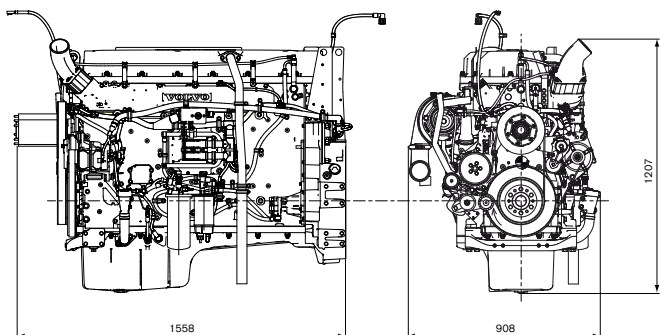

Note! Not all models, standard equipment and accessories are available in all countries. All specifications are subject to change without notice. The engine illustrated may not be entirely identical to production standard engines.

Power Standards

The engine performance corresponds to ISO 3046, BS 5514 and DIN 6271. The technical data applies to an engine without cooling fan and operating on a fuel with calorific value of 42.7 MJ/kg (18360 BTU/lb) and a density of 0.84 kg/litre (7.01 lb/US gal, 8.42 lb/Imp gal), also where this involves a deviation from the standards.

Rating Guideline

IFN Power rating corresponds to ISO Overload Power. It is intended for applications where intermittent power is utilized less than 1 hour within any period of 12 hours of continuous operation. The average load factor must not exceed the continuous rating.

ICFN Power rating corresponds to ISO Standard Power for continuous operation. It is intended for constant load applications with uninterrupted service at full load for extended periods of time. The average load factor must not exceed 70% of the continuous rating when operating at continuous speed and load.

Derating

For derating information please see technical diagrams available on request from Volvo Penta.

Standard and optional equipment

Engine

Automatic belt tensioner •

Lift eyelets •

Flywheel

Flywheel housing with conn. acc. to SAE 1 •

Flywheel for 14" flex. plate and flexible coupling •

Engine suspension

Fixed front suspension •

Lubrication system

Oil dipstick •

Oil dipstick, flexible -

Full-flow oil filter of spin-on type •

By-pass oil filter of spin-on type •

Remote oil filter of spin-on type -

Oil cooler, side mounted •

Low noise oil sump •

Fuel system

Fuel filters of disposable type •

Electronic unit injectors •

Pre-filter with water separator •

Intake and exhaust system

Air filter with replaceable paper insert •

Air restriction indicator •

Air cooled exhaust manifold •

Connecting flange for exhaust pipe •

Exhaust flange with v-clamp •

Turbo charger, low right side •

Engine mounted silencer -

Crankcase ventilation, open -

Crankcase ventilation, closed -

Cooling system

Radiator incl intercooler -

Coolant pump •

Fan hub •

Suction fan -

Pusher fan -

Electronically controlled viscous fan drive -

Fan guard -

Belt guard -

Control system

Engine Management System (EMS) with •

CAN-bus interface SAE J1939 •

CIU, Control Interface Unit -

DCU, Display Control Unit -

Alternator

Alternator 80A / 28V •

Alternator 110A / 28V -

Starting system

Starter motor 7kW, 24V •

Connection facility for extra starter motor •

Air inlet pre-heater -

Instruments and senders

Temp.- and oil pressure for automatic •

stop/alarm -

Other equipment

Air compressor, 1 cylinder -

Air compressor, 2 cylinders -

AC compressor -

Power steering pump -

Crankshaft pulley 4 x HC50 -

Engine block heater, 230V, 1500W -

Engine Packing

Plastic wrapping •

- optional equipment

• included in standard specification

For our full range of optional equipment, please see order specification.



AB Volvo Penta
SE-405 08 Göteborg, Sweden
www.volvopenta.com